

**STEEL FOUNDERS' SOCIETY OF AMERICA**

**MATERIALS TECHNOLOGY INSTITUTE**

**THE UNIVERSITY OF IOWA**

**ROUND-ROBIN SIMULATION EXERCISE  
TO EVALUATE NIYAMA CRITERION**

**Background**

- A radiograph does not always provide an accurate indication of shrinkage defects in steel castings:
  - large uncertainty in reading x-ray and assigning level;
  - micro-shrinkage may not be detected.
- The Niyama criterion, as evaluated in all casting simulation software, is known to provide a robust prediction of micro- and macro-shrinkage. The Niyama criterion is a local thermal parameter and is defined as the local thermal gradient divided by the square root of the cooling rate:  $Ny = G / \sqrt{\dot{T}}$ . Unlike radiographs, the Niyama criterion values can be obtained before any castings are poured. Furthermore, it provides quantitative information that may be correlated to the extent and severity of a shrinkage defect.
- Ideally, for the same casting alloy, geometry and process conditions, the same Niyama values should be predicted. However, casting simulation is a complex process that requires much user input. Some of the critical issues in the prediction of the Niyama criterion are: (i) some software may provide inaccurate predictions due to the nature of the numerical approximations made internally; (ii) different software may evaluate the Niyama criterion differently (e.g., units used, temperatures at which the thermal gradient and cooling rate are evaluated, etc.); (iii) the thermophysical properties of an alloy/mold material, which are needed in a casting simulation, may not be known or well established; (iv) the initial and boundary conditions may not be accurately known or input (pouring temperature, mold/metal interfacial heat transfer coefficient, ambient heat transfer, etc.); and (v) the choice of the numerical grid and time steps will depend on the software user and available computing power.

**Objective**

- To conduct a round-robin simulation exercise to assess variations in the evaluation of the Niyama criterion for steel castings among various casting simulation packages and their users. The present round-robin is *not* intended to assess the correlation between Niyama predictions and actual shrinkage defects in steel castings.

## **Description of the CAD files**

The University of Iowa has provided you with CAD files (in .stl format), which represent the complete casting geometry (i.e. valve, riser and mold box). Altogether, there are 4 files representing the geometry of different components. The names of the files and their description is as follows:

a) Name: moldbox.stl

Description: contains the geometry of the mold box

b) Name: riser.stl

Description: contains the geometry of the riser

c) Name: valve.stl

Description: contains the geometry of the valve

d) Name: riserandvalve.stl

Description: contains the geometry of the valve and riser together

An overview of the use of the .stl files is given as follows:

- The file (a) needs to be loaded into your simulation software
- Some software packages may require that the riser and valve be input as separate entities, and therefore it may be necessary to load their geometries using the separate .stl files (b) and (c).
- However, if that is not the case with your software, then file (d) can be loaded into your simulation software instead of files (b) and (c).
- Regardless of whether you load (a), (b) and (c) or just (a) and (d), the geometries need to be oriented as shown on the following pages.

## Simulation Procedure

- 1) Take the .stl files and import them into your simulation software. As a check, some key dimensions of the casting, riser and mold box are as follows:

Outer diameter of the thinner flange: 588 mm  
Outer diameter of the thicker flange: 606 mm  
Diameter of the riser: 223 mm  
Mold box dimensions: 816 x 816 x 1372 (all in mm)

- 2) Orient the geometries as indicated in the figures below (all dimensions are in mm).

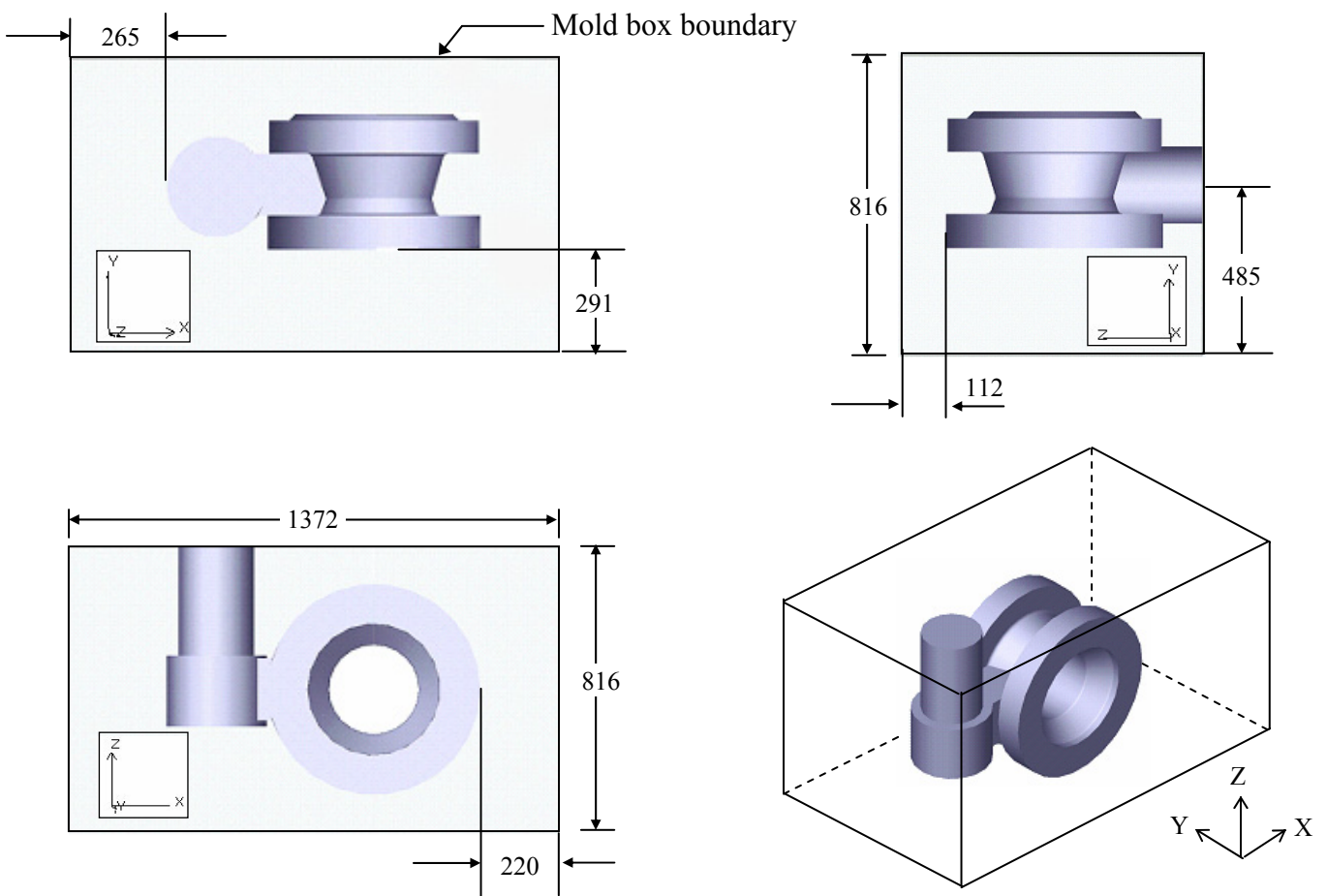

### 3) Running the simulation

- Please ensure that all simulations are based on the following criteria:
  - **Solidification only** (i.e., run without filling)
  - Use pepset sand and assume hot topping is used on riser
- We are collecting and analyzing simulation results for the following four metal alloys. Please conduct simulations on as many of these alloys as you are able (please use the properties that you would normally use for a given alloy designation; if you do not have the properties for an alloy, do not perform simulations for that alloy; results for even one alloy will be highly appreciated):

<u>Metal</u>	<u>Superheat (°C)</u>
- WCB	20
- CF-8M	100
- CN-7M	100
- M-30C	100

Note: Superheat is defined as the difference between the initial temperature and liquidus temperature; it thus defines the initial temperature of the steel.

- Record the number of metal cells or metal elements used for the simulations on the data sheet provided.
- Prepare Niyama results as described in the next section

### **Preparation of the results**

- 1) For each alloy simulated, please plot the Niyama criterion results, in the form of slices on three locations A, B, and C, shown on the next page.
- 2) Please note that this study is not interested in correlating Niyama values with shrinkage. This study is only intended to compare Niyama values from different simulation packages and users. Also note that we intend to extract Niyama values, particularly the lower values, from your simulation pictures. Bearing this in mind, use your best judgment when selecting the color scale for the Niyama values in the requested simulation result pictures. Since there could be a large disparity between maximum and minimum Niyama values in a given result view, please use care in selecting a color scale that shows the Niyama values (particularly the lower values) in a clear fashion.

IT IS VERY IMPORTANT to make sure that the Niyama value color scale is included in each of your Niyama result pictures, complete with the numbers (Niyama values) corresponding to each color band. Because the units of the Niyama criterion may vary from one simulation package to another, please enter the units for the Niyama criterion used by your simulation package on the data sheet provided.

- The positions A, B and C are illustrated as follows:

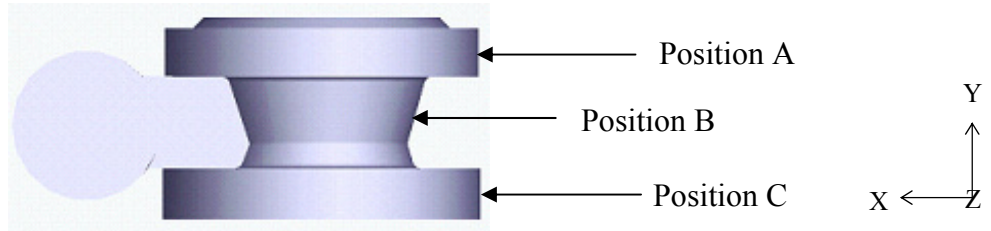

- A) The slice through half of the thickness of the thinner flange.
- B) The slice through half of the valve body (not through the thinnest section of the body).
- C) The slice through half of the thickness of the thicker flange.

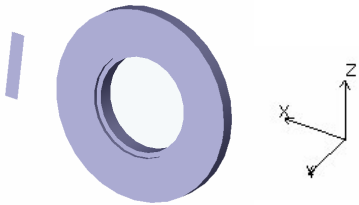

Position A (three-dimensional view)

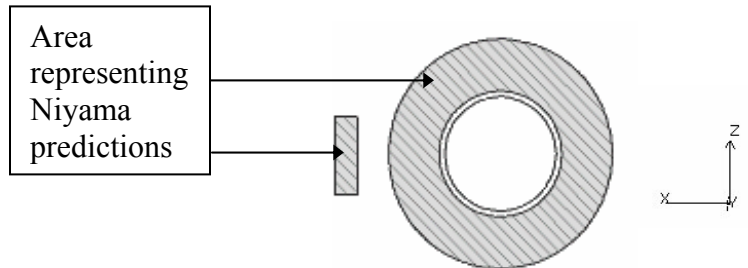

Position A (two-dimensional view)

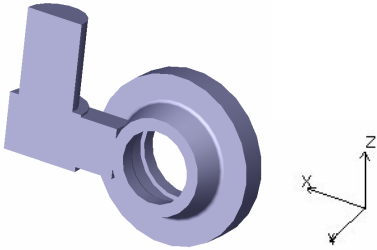

Position B (three-dimensional view)

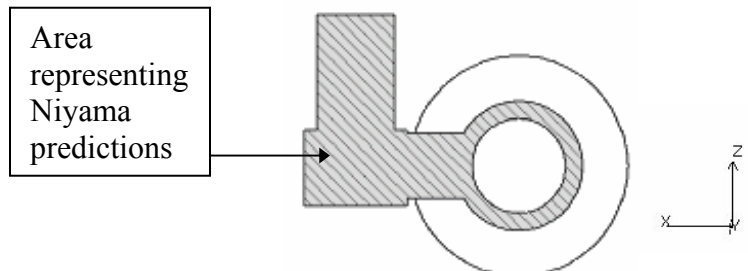

Position B (two-dimensional view)

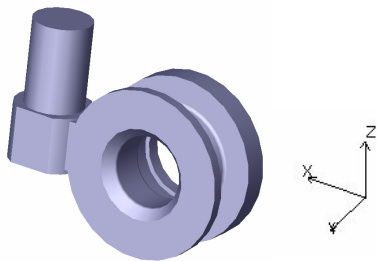

Position C (three-dimensional view)

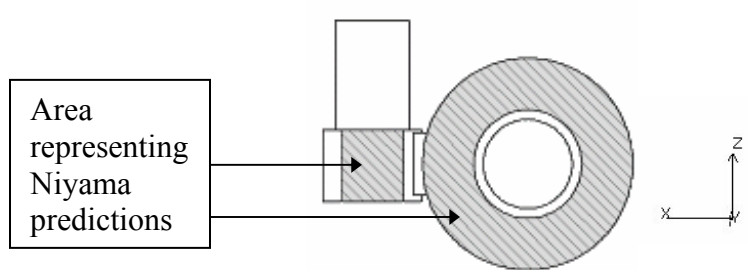

Position C (two-dimensional view)

These views are to clarify the location of the desired results.

Please use these views for your Niyama result pictures.

## **Checklist of the simulation results to be returned**

1) Completed data sheet, indicating the information as accurately as possible

Note: Upon completion, please e-mail or mail the simulation data sheet provided to the address given below.

2) For each of the alloys simulated, pictures of the 3 requested two-dimensional views indicating the Niyama predictions. You can choose one of the following options to send this data:

- a) Save the pictures in any format (i.e. .JPEG, .BMP, etc.) and e-mail them to the e-mail address given below.
- b) Save the pictures in any format (i.e. .JPEG, .BMP, etc.), burn them all onto a CD and mail it along with the data sheets to the address given below.
- c) Mail hardcopy printouts of each picture along with the data sheets to the address given below:

Please return all the data sheets and pictures to the following address:

**Kent Carlson, Research Engineer**  
**Solidification Laboratory**  
**Department of Mechanical & Industrial Engineering**  
**2430 SC**  
**The University of Iowa**  
**Iowa City, Iowa 52242**

e-mail: [kdcarls@engineering.uiowa.edu](mailto:kdcarls@engineering.uiowa.edu)

*All information provided will be held in complete confidence; no name or affiliation of any participant will be revealed. Only summary results will be published.*

## Simulation Data Sheet

Please note that this information will be held confidential.

Company Name	
Contact Person	
e-mail address	
Phone Number	
	Fax Number

Please fill in the following blanks regarding the simulations:

Simulation package used \_\_\_\_\_

Number of metal cells or metal elements used for the simulations \_\_\_\_\_

Units of the Niyama criterion in your simulation package \_\_\_\_\_

- In the following table, please fill in the values of the **liquidus temperature ( $T_L$ )** and the **temperature at which the alloy is 100% solid ( $T_S$ )** for each of the alloys simulated. In every case, please be sure to specify the units (i.e. °C or °F).

- In the table, please also
  - Enter the value of the temperature ( $T_{NY}$ ) at which the Niyama criterion is evaluated. Please be sure to specify the units (i.e. °C or °F).

**OR**

- Indicate where in the solidification range (which is defined as ( $T_L - T_S$ )) the Niyama criterion is evaluated. (For example, 10% of the solidification range above the temperature at which the metal is 100% solid).

Alloy	$T_L$	$T_S$	$T_{NY}$	Where in the solidification range
WCB				
CF-8M				
CN-7M				
M-30C				

Please return the data sheet and pictures to the following address:

**Kent Carlson, Research Engineer**  
**Solidification Laboratory**  
**Department of Mechanical & Industrial Engineering**  
**2430 SC**  
**The University of Iowa**  
**Iowa City, Iowa 52242**

e-mail: [kdcarls@engineering.uiowa.edu](mailto:kdcarls@engineering.uiowa.edu)